

LED-25W Series Fixed Output and Dimmable Switch Mode LED Drivers



Electrical Specifications

Input Voltage Range:	100-277 Vac Nom. (90-305 V Min/Max)
Input Over-Voltage:	Can endure 320Vac for 48 Hrs, 350Vac for 2 Hrs
Frequency:	50/60 Hz Nom. (47-63 Hz Min/Max)
Power Factor:	>0.90 @ full load, 100V through 277V
Inrush Current:	<15.0 Amps max @ 230 Vac, cold start 25°C
Input Current (Max):	0.25 Amps max @ 120 Vac
Maximum Power:	25W
Current Accuracy:	± 1% Over input line variation
Load Regulation:	± 3%
THD:	≤ 20% @ full load
Turn-On Delay:	<1.0 Sec. @ full output; 1-4 Sec. @ full dim
Leakage Current:	400 µA Typical
Hold Up Time:	Half Cycle

Protections

Over-voltage	Output
Over-current	Output
Short Circuit	Auto Recovery

Environmental Specifications

Max Case Life Temp: (5 year warranty)	72°C
Maximum Case Temp (UL):	90°C
Minimum Starting Temp:	-30°C
Storage Temperature:	-40°C to +85°C
Humidity:	5% to 95%
Cooling:	Convection
Vibration Frequency:	5 to 55 Hz/2g, 30 minutes
Sound Rating:	Class A
MTBF:	482,000 Hours at full load and 40°C ambient conditions per MIL-217F Notice 2
EMC:	FCC 47CFR Part 15 Class B compliant

- Total Power: 25 Watts
- Input Voltage: 100-277 Vac Nom.
- UL Dry & Damp Location Rated
- High Power Factor
- UL8750 and Class 2 Compliant, as noted
- Constant Current & Constant Voltage with Isolation
- Black Magic Thermal Advantage™ Plastic Housing
- UL Sign Components Manual (S.A.M. Models)

Dimming Option:

0-10V & Resistance dimmable models include an extra two wires +Purple/-Gray on the output side. "D" Compatible with most quality 0-10V wall dimmers. See page 3 for additional specifications.

Note:

LED drivers are designed and intended to operate LED loads only. Non-LED loading may be outside the specified design limits of our LED drivers, and therefore cannot be covered by any warranty. If you desire to use our LED drivers to operate non-LED loads please contact us to discuss compatibility.



Constant Current Models

Model	Current Out (mA ±3%)	Voltage Out Range (Vdc)	Max Power (W)	Typical Efficiency
LED25W-72-C0350-XX	350	24-72	25	86%
LED25W-40-C0350-XX	350	13-40	14	84%
LED25W-28-C0350-XX	350	10-28	9.8	83%
LED25W-62-C0400-XX	400	21-62	24.8	85%
LED25W-56-C0450-XX	450	19-56	25	84%
LED25W-40-C0500-XX	500	13-40	20	84%
LED25W-40-C0620-XX	620	13-40	24.8	84%
LED25W-36-C0700-XX	700	12-36	25	84%
LED25W-28-C0850-XX	850	10-28	23.8	83%
LED25W-24-C1040-XX	1040	8-24	25	83%
LED25W-20-C1250-XX	1250	7-20	25	83%
LED25W-18-C1400-XX	1400	6-18	25	82%
LED25W-16-C1560-XX	1560	6-16	25	82%
LED25W-14-C1750-XX	1750	5-14	24.5	82%
LED25W-12-C2080-XX	2080	4-12	25	81%

-XX indicates dimming options are available. See options at left. Blank = fixed current output

Constant Voltage Models

Model	Voltage Out (Vdc ±5%)	Current Out Range (mA)	Max Power (W)	Typical Efficiency
LED25W-12 •	12	520-2080	25	81%
LED25W-14	14	438-1750	24.5	82%
LED25W-16	16	390-1560	25	82%
LED25W-18	18	360-1400	25	82%
LED25W-20	20	313-1250	25	83%
LED25W-24 •	24	260-1040	25	83%
LED25W-28	28	213-850	23.8	83%
LED25W-36	36	175-700	25	84%
LED25W-40	40	155-620	24.8	84%
LED25W-56	56	113-450	25	84%
LED25W-62	62	100-400	24.8	85%
LED25W-72	72	88-350	25	86%

• Indicates S.A.M. Class 2: US/Canada



Dimensions

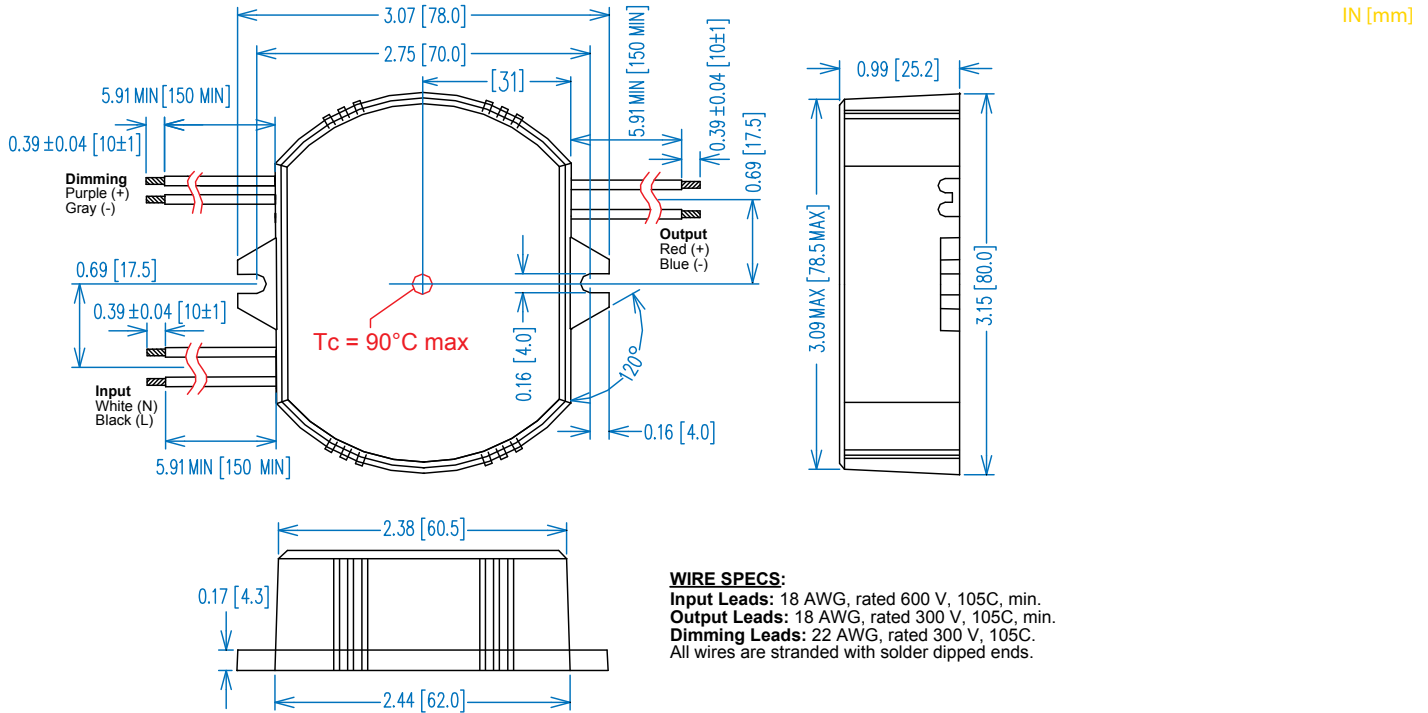

Power Characteristics

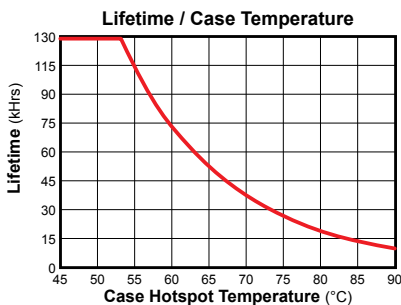
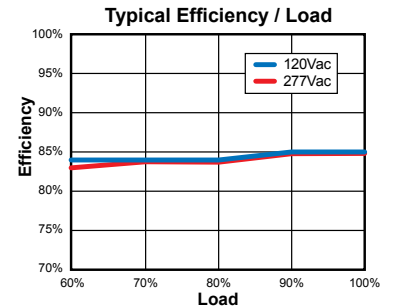
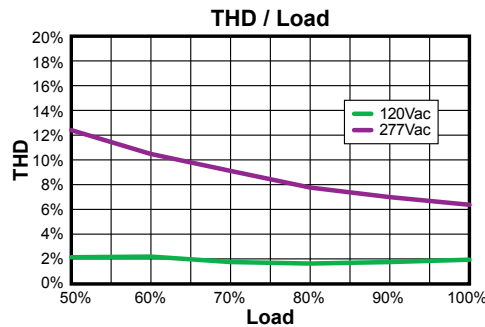
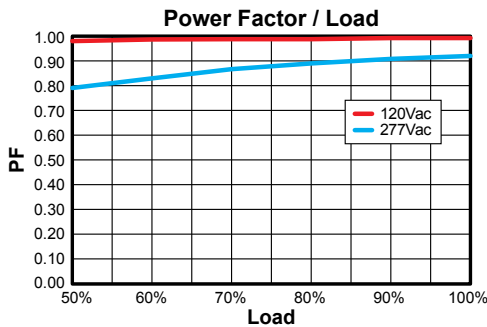

Safety Cert.	Standard
UL/CUL	UL8750
CSA	22.2
CE	EN61347
EMC Standard	Notes
EN61000-3-2	
EN61000-3-3	Class C
FCC, 47CFR Part 15	Class B
EN6100-4-5	2KV L-N, 8/20 μsec Surge Protection

Note: The area under the life-temperature curve represents where the driver has highly reliable operation within specification. Driver performance may drift out of published specifications as the hours of operation exceed the curve at a given temperature. Higher operating temperatures increase the chances of a failure to function. Other electrical, mechanical and environmental factors affect driver lifetime but are not represented in this calculation.

UL Conditions of Acceptability

See website for additional information

“-D” Option: 0-10VDC and Resistance Dimming

Parameters	Minimum	Typical	Maximum
Source Current out of 0-10V Purple Wire	0 mA	—	2 mA
Absolute Voltage Range on 0-10V (+) Purple Wire	-2.0V	—	+15 V

Typical Dimming Circuit

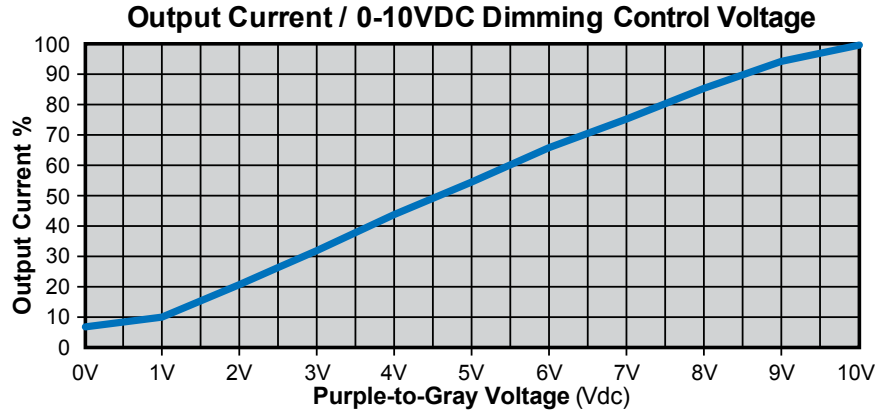
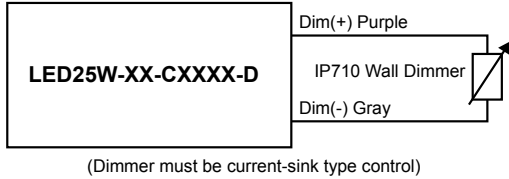

Notes:

- 0-10V dimmable version comes with an extra two wires +Purple/-Gray on the output side.
- Compatible with most 0-10V dimmers. Recommended dimmer is Leviton IP710 or equivalent
- 0-10V dimmable version is not intended to dim below about 5% @ 0V or 10% @ 1.0V
- 0-10V dimmable version output will be 100% with Purple/Gray open and minimum with Purple/Gray Shorted.